



HAMMOND  
MANUFACTURING™

# Datacom/Telecom Racks & Cabinets Catalog

## Relay Racks - DNRR Series - 2-Post Steel (Welded)



The Hammond DNRR series 2-Post relay rack is a popular choice for a variety of networking, instrument and telecom applications.

- Suitable for many 19" rack mount applications, providing complete access to equipment
- No assembly required (fully welded)
- Recommended maximum weight - 1,500 lbs
- Pre-tapped holes (10-32)
- Choice of front flange or both flanges tapped
- 10 gauge steel construction
- Premium black powder paint

### Tapped - Front Flange Only...

Part No.	Description	Panel Height
DNRR42HDW	2-Post Relay Rack	24U (42")
DNRR77HDW	2-Post Relay Rack	44U (77")

### Tapped - Front and Rear Flange...

Part No.	Description	Panel Height
DNRR77HDWB	2-Post Relay Rack	44U (77")

These are our most popular sizes! Hammond offers many more Relay Racks varying in size, material and design!

Please visit our web site for more information:

[www.hammondmfg.com](http://www.hammondmfg.com)

## Relay Rack Options

RRCM Series Cable Chimneys connect directly to our vertical cable managers!

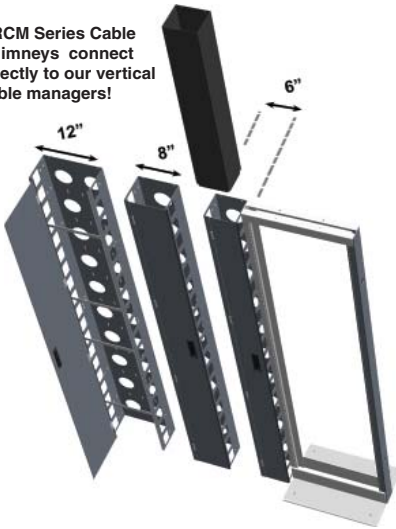

### Vertical Cable Managers

- Available in three widths (6", 8", 12")
- Hinged doors secured with magnets
- Can mount on left or right of rack
- Managers can also bay racks
- 16 gauge steel
- Includes req. mounting hardware

### Cable Chimneys

Cable Chimneys are assembled from two halves, making it easy to attach around existing cables.

- Attaches directly to Vertical Managers
- 18 gauge steel
- Easy installation
- Mounting hardware included

Part No.	Description	Profile
RRCM44UD	44U Manager w/Door	6" x 5"
RRCM844UD	44U Manager w/Door	8" x 6"
RRCM1244UD	44U Manager w/Door	12" x 6"

These are our most popular sizes! Hammond offers more Vertical Cable Managers varying in size, material and design! Please visit our web site for additional models.

Part No.	Description	Profile
RRCMCH65	Cable chimney	6" x 5" x 36"
RRCMCH86	Cable chimney	8" x 6" x 36"
RRCMCH126	Cable chimney	12" x 6" x 36"

\* Note: The above cable chimneys are designed to connect directly to our vertical cable managers, and are not compatible with our Top Horizontal Cable Manager (HCM) System below.

Top Horizontal Cable Manager (HCM) System  
(Compatible with 6" wide vertical cable managers only)

Fig.	Part#	Compatible With...
A	RR19TMS	(1) rack with (1) vertical cable manager
B	RR19TMD	(1) rack with (2) vertical cable managers
C	RR19TMDD	(2) racks with (2) vertical cable managers
D	RR19TMDT	(2) racks with (3) vertical cable managers

### HCM System Components

Fig.	Part#	Description
J	RRTMEP	End-Plates to close Top Cable Manager ends
K	RRTMJK	Joining kit - Joins Top horiz. managers together

### HCM Compatible Chimneys\*

Fig.	Part#	Description	Diameter	Height
E	RRCH20	HCM Cable chimney	6" x 5"	20"
	RRCH24	HCM Cable chimney	6" x 5"	24"
	RRCH30	HCM Cable chimney	6" x 5"	30"

\* HCM chimneys are compatible only with above HCM system

### Compatible Casters and Dollies

Fig.	Part#	Description	Rated	Height Added to Rack
G	RRLDCASTER	Light Duty Casters(4)	800 lbs	3.76"
H	RRLPDOL	Low Profile Dolly	1080 lbs	1.25"
I	RRHDDOL	Heavy Duty Dolly	1500 lbs	3.50"

### Baying Hardware

Fig.	Part#	Description
L	RRALJK	Baying kit - Joins two DNRR racks together

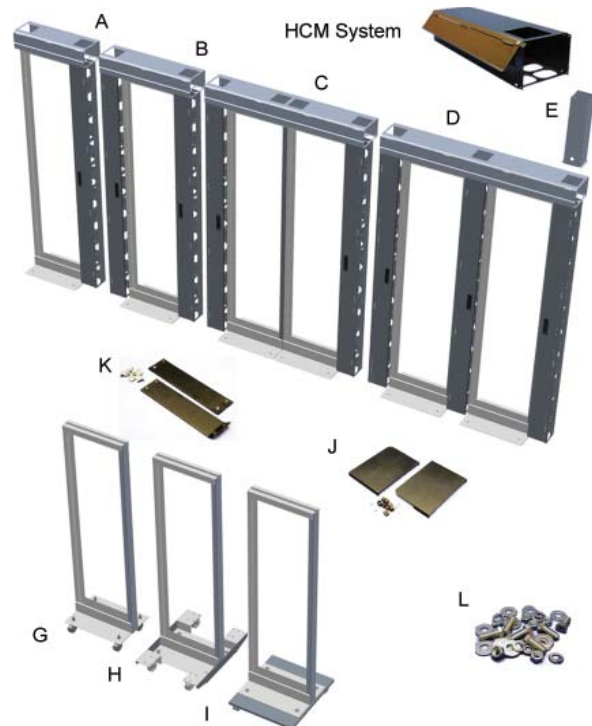

## 4-Post Relay Racks / Open-Server Racks - (DC4R Series)

### DC4R 4-POST "Adjustable-Depth" Rack

The Hammond DC4R Open Rack series is one of the most economic solutions to house servers and other devices in computer rooms or data centers. In situations where the computer room itself is under lock and key and accessed by a limited number of people, full cabinets having locking doors and side panels may not be required therefore resulting in a significant cost savings. Having a "knock-down" design, the rack can also be delivered to places where welded frames and cabinets may not.

- Ships unassembled (flat-pack)
- Available in 44U and 24U spaces
- 83" or 46" over-all height
- 24" to 36" adjustable over-all depth
- 20.5" over-all width
- 19"-mounting front and back
- 12 gauge universal square-hole mounting
- Unit space markers
- Premium black textured (powder) paint
- Load capacity 2000 lbs
- Includes 1 x (set of 2) horizontal cable manager bars (DC4RSHCM)
- Additional cable manager bars available



#### Cable Management

The DC4R44 is compatible with ALL vertical & horizontal cable managers available for our DNR77HDW 2-post Relay Racks. See PAGE 2.



Part#	Description
DC4R44	44U 4-Post Rack Kit
DC4R24	24U 4-Post Rack Kit
RRALJK	Standard Baying Hardware Kit
DC4RSHCM	Additional Horizontal Cable Bars(2)
RRLDCASTER	Light duty Casters (4) Weight load 800 lbs total



DC4RSHCM  
Horizontal Cable Manager Bars  
with Adjustable Depth

## Relay Rack Popular Accessories

### Shelves (2-Post Mounting):

Part Number	Description	Units	Depth	Rated
RASU190115BK1	Cantilever Solid Shelf	1U	15"	40lbs
RASU190120BK1	Cantilever Solid Shelf	1U	20"	40lbs
RASU190315BK1	Cantilever Solid Shelf	2U	15"	100lbs
RASU190320BK1	Cantilever Solid Shelf	2U	20"	100lbs
RASU190515BK1	Cantilever Solid Shelf	3U	15"	200lbs
RASU190520BK1	Cantilever Solid Shelf	3U	20"	200lbs
RASU190715BK1	Cantilever Solid Shelf	4U	15"	200lbs
RASU190720BK1	Cantilever Solid Shelf	4U	20"	200lbs
RASV190115BK1	Cantilever Vented Shelf	1U	15"	40lbs
RASV190120BK1	Cantilever Vented Shelf	1U	20"	40lbs
RASV190315BK1	Cantilever Vented Shelf	2U	15"	100lbs
RASV190320BK1	Cantilever Vented Shelf	2U	20"	100lbs
RASV190515BK1	Cantilever Vented Shelf	3U	15"	200lbs
RASV190520BK1	Cantilever Vented Shelf	3U	20"	200lbs
RASV190715BK1	Cantilever Vented Shelf	4U	15"	200lbs
RASV190720BK1	Cantilever Vented Shelf	4U	20"	200lbs

DNDMS19BK1	Relay Rack Modem Shelf - Solid	2U	19.5"	200lbs
DNDMV19BK1	Relay Rack Modem Shelf - Vented	2U	19.5"	200lbs

DNRMA1916BK1	Cantilever Adjustable Shelf	3U	16"	275lbs
DNRMA1920BK1	Cantilever Adjustable Shelf	3U	20"	275lbs

DNRMU19BK1	Dual-Channel Solid Shelf	3U	19"	300lbs
DNRMU1924BK1	Dual-Channel Solid Shelf	3U	24"	300lbs
DNRMV19BK1	Dual-Channel Vented Shelf	3U	19"	300lbs
DNRMV1924BK1	Dual-Channel Vented Shelf	3U	24"	300lbs

DNRMM19BK1	Dual-Channel Monitor Shelf w/storage	3U	19"	300lbs
------------	--------------------------------------	----	-----	--------

RKBM19BK1	Cantilever Keyboard/Monitor Shelf	3U	15"	160lbs
-----------	-----------------------------------	----	-----	--------

### Shelves (4-Post Mounting):

Part Number	Description	Units	Surface Depth	Mounting Depth	Rated
RSVS1918BK1	Sliding Shelf - Vented	1U	18"	20"	120lbs
RSVS1921BK1	Sliding Shelf - Vented	1U	21"	22"	120lbs
RSVS1926BK1	Sliding Shelf - Vented	1U	26"	28"	120lbs
RSVS1931BK1	Sliding Shelf - Vented	1U	31"	30"	120lbs
RSUS1918BK1	Sliding Shelf - Solid	1U	18"	20"	120lbs
RSUS1921BK1	Sliding Shelf - Solid	1U	21"	22"	120lbs
RSUS1926BK1	Sliding Shelf - Solid	1U	26"	28"	120lbs
RSUS1931BK1	Sliding Shelf - Solid	1U	31"	30"	120lbs

RSLIDEEX	Bracket Upgrade - Increase RSVS/US Mounting-Depth by 14"				
----------	--	--	--	--	--

RMASU1925BK1	Adj.Depth Shelf - Solid	1U	25"	25" - 35"	75lbs
RMASU1930BK1	Adj.Depth Shelf - Solid	1U	30"	30" - 40"	75lbs
RMASV1925BK1	Adj.Depth Shelf - Vented	1U	25"	25" - 35"	75lbs
RMASV1930BK1	Adj.Depth Shelf - Vented	1U	30"	30" - 40"	75lbs
RMASHD1925BK1	Adj.Depth Shelf - Vented	2U	25"	25" - 35"	200lbs

### Keyboard Drawers (4-Post Mounting Only):

Part Number	Description	Units	Surface Depth	Mounting Depth	Rated
RAKS19BK1	Narrow Keyboard Drawer	2U	15"	18"	120lbs
RSLIDEEX	Bracket Upgrade - Increase RSVS/US Mounting-Depth by 14"				

RSKS19005BK1	Full-Size Keyboard Drawer	3U	18"	34"	120lbs
--------------	---------------------------	----	-----	-----	--------

### Storage Drawers (4-Post Mounting Only):

Part Number	Description	Units	Surface Depth	Mounting Depth	Rated
RDRW1900322BK1	Locking Drawer	2U	22"	24"	120lbs
RDRW1900522BK1	Locking Drawer	3U	22"	24"	120lbs
RDRW1900722BK1	Locking Drawer	4U	22"	24"	120lbs
RDRW1900822BK1	Locking Drawer	5U	22"	24"	120lbs
RDRW1901222BK1	Locking Drawer	7U	22"	24"	120lbs

These are our most popular drawer sizes. 12" and 16" deep models are also available. Please visit our website for more information.

### Cable Management Products:

Part Number	Description	Units	Overall Height	Overall Depth
PCMD19001BK1	Hinged Horizontal Cable Manager	1U	1.75"	2.5"
PCMD19003BK1	Hinged Horizontal Cable Manager	2U	3.5"	2.5"
PCMD19005BK1	Hinged Horizontal Cable Manager	3U	5.25"	2.5"
PCMD19001BK1	Hinged Finger Panel	1U	1.75"	3"
PCMD19003BK1	Hinged Finger Panel	2U	3.5"	3"
PCMD19005BK1	Hinged Finger Panel	3U	5.25"	3"
CMRBV19001BK1	Velcro Strap Panel	1U	1.75"	-
CMRBK1	Single Cable Ring - 1.25" Wide	1U	1.75"	3.5"
CMR3BK1	Single Cable Ring - 1.25" Wide	2U	3.5"	3.5"
PCMT19003BK1	Rack Panel Mount Trough	2U	3.5"	-
CGUIDE	Hinged Cable Guide w/tie straps	2U	3.5"	-
CMSTRAP5	5 Velcro Straps - Supports Max. 3.5" diameter bundles			

### Power Distribution Products:

Part Number	Description	Cord Length	# of Outlets	Overall Height	Amp Rating
1588T12A1BK	Vertical Strip (Black)	6'	12	77"	15Amp
1585477A1	Vertical Strip (Silver)	6'	7	42"	15Amp
1582T6A1BK	Horizontal Strip	6'	6	1.72"	15Amp
1582T8A1BK	Horizontal Strip	6'	8	1.72"	15Amp
1589H6F1BKRR	Horizontal Strip	6'	6	1.72"	20Amp
1583T6A1BKAM	Horiz. Strip w/Ammeter	6'	6	1.72"	15Amp
1589T6F1BKRRAM	Horiz. Strip w/Ammeter	6'	6	1.72"	20Amp

The above Power Distribution Products consist of only a few product models. Please see page 10 for the full list of models and specifications.

# Wall-Mount Solutions

## APB Series - Adjustable-Depth Panel Mount Rack

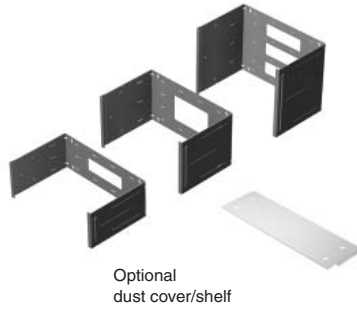

Enhanced rack bracket with adjustable depth to mount 19" rackmount devices to a wall.

Part#	Description	
APB19007BK1	Wall Bracket	4U (7")
APB19010BK1	Wall Bracket	6U (10.5")
APB19014BK1	Wall Bracket	8U (14")
APB19021BK1	Wall Bracket	12U (21")
PBCOVER	Dust cover/shelf	6" Deep

### Features:

- New knock-down design
- Ships unassembled (flat-pack)
- Double-hinged for easy rear access to devices.
- Adjustable depth from 12" to 18" using slots for easy set-up and adjusting.
- Multiple tie points for cable management.
- Pre-tapped 10-32 holes are EIA compliant.
- Weight load tested to 70lbs.
- Generous cable access hole(s).
- Durable textured black powder paint finish.
- Includes 10-32 black rack screws w/washers and mounting template for easy installation.

\* Please visit our web site for further specifications and accessories. [www.hammondmfg.com](http://www.hammondmfg.com)

## HPB Series - Fixed-Depth Panel Mount Rack

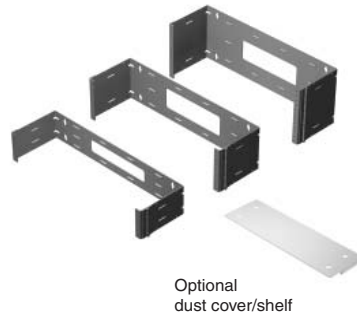

Cost-effective, fixed-depth rack bracket for mounting 19" rackmount devices to a wall.

Part#	Description	
HPB19003BK1	Wall Bracket	2U (3.5")
HPB19005BK1	Wall Bracket	3U (5.25")
HPB19007BK1	Wall Bracket	4U (7")
PBCOVER	Dust cover/shelf	6" Deep

### Features:

- Hinged for easy rear access to devices.
- Fixed-depth of 6".
- Multiple tie points for cable management.
- Pre-tapped 10-32 centers are EIA compliant.
- Weight load tested to 100lbs.
- Generous cable access hole(s).
- Durable textured black powder paint finish.
- Includes 10-32 black rack screws w/washers and mounting template for easy installation.

\* Please visit our web site for further specifications and accessories. [www.hammondmfg.com](http://www.hammondmfg.com)

## WMC Series - Wall-mount Cabinet

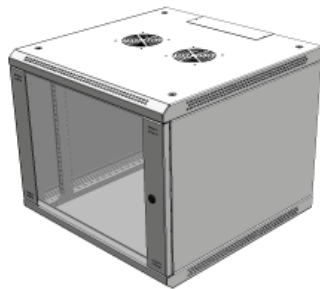

- Quick and easy bolt-together field assembly and flat pack makes storage/shipping cost effective.
- Provides standard 19" rack mounting
- High quality, light textured powder coat finish (black)

Part Number	Panel Height	Overall Dim's (mm)		
		H	W	D
WMC1901023BK2	6U	369 (14.5")	600 (23.6")	600 (23.6")
WMC1901523BK2	9U	503 (19.8")	600 (23.6")	600 (23.6")
WMC1902123BK2	12U	636 (25.0")	600 (23.6")	600 (23.6")
WMC1902623BK2	15U	769 (30.3")	600 (23.6")	600 (23.6")

Note: Usable depth = 540mm (21.25")

### Features:

- Sturdy cold-rolled steel components provide static load capacity of 60kg (130lbs.)
- Ventilation slots front and side
- Optional fans can be added into top cutouts
- Cable access panels top and bottom
- 2 pair of L-shape painted mounting rails - square hole design, includes 20 screws and push-in nuts, and rail depth can adjust in 25mm increments
- Glass door provides full view of equipment with full 180 degree opening, can be easily be removed and hinged in either direction, and complete with lock and key

## SWCC Series - Swing-out Wall-mount Cabinet

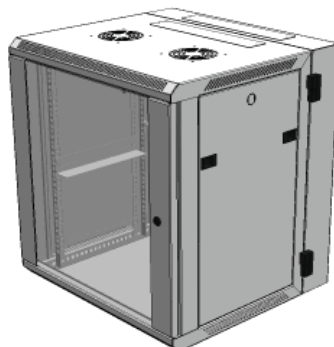

- Overall depth of 550mm (21.6") includes 100mm (3.9") deep wallmount section and 450mm (17.7") deep hinged cabinet body
- Quick and easy wall mounting system
- Provides standard 19" rack mounting
- High quality, light textured powder coat finish (black)

Part Number	Panel Height	Overall Dim's (mm)		
		H	W	D
SWCC1901021BK2	6U	384 (15.1")	600 (23.6")	550 (21.7")
SWCC1901521BK2	9U	518 (20.4")	600 (23.6")	550 (21.7")
SWCC1902121BK2	12U	651 (25.6")	600 (23.6")	550 (21.7")
SWCC1902621BK2	15U	784 (30.9")	600 (23.6")	550 (21.7")
SWCC1903121BK2	18U	918 (36.1")	600 (23.6")	550 (21.7")

Note: Usable depth = 414mm (16.2")

### Features:

- Sturdy cold-rolled steel frame has static load capacity of 60kg (130lbs.)
- Ventilation slots front and side and optional fans can be added into top cutouts
- Hinged cabinet body can open 120 degrees and secured to wallmount section by lock and key
- Wallmount section has cable access panels top and bottom
- 2 pair of L-shape painted mounting rails - square hole design, includes 20 screws and push-in nuts, and rail depth can adjust in 25mm increments
- Glass door provides full view of equipment with full 180 degree opening, can be easily removed and hinged in either direction, and complete with lock and key
- Pair of solid side panels are removable
- Locks for side panels available. Part No. SWCCLOC

# (User-Assembled) Rack Cabinet Systems



## RCSC Series "STACKING" Cabinets - Servers, Storage & Networking



RCSC 12U, 36" deep cabinet shown here with optional perforated doors installed.

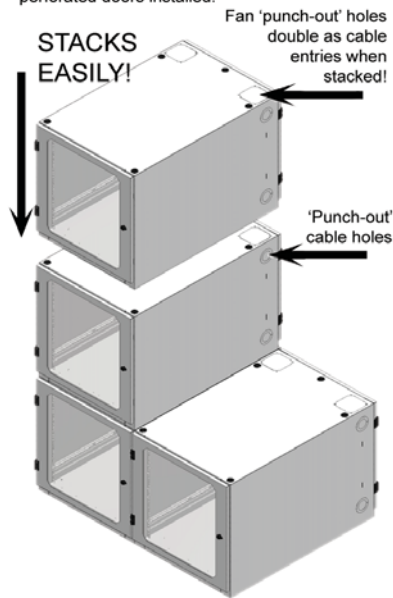

### RCSC User-Assembled "STACKING" Cabinet System

The Hammond RCSC Rack Cabinet features a similar, easy-to-assemble design as our popular RCHV series (below), but with extensive enhancements designed to support SERVER and general computer applications.

The most unique feature of the RCSC series is its ability to stack VERTICALLY! This cabinet grows with you, thanks to its generous rear cable channel space and its top/bottom cable pass-through feature.

#### Key Features:

- Unique Stackable design.
- 24" over-all width provides ample space for most cabling requirements.
- 36" deep version has extended cable space in the back and provides adequate mounting support for most deep-server applications.
- 12U version is 25" high (fits under most desks).
- Univ. EIA-compliant square-hole mounting rails.
- User-assembled (ships flat).
- Weight-load rating of 1500lbs.
- Generous cable-entry 'punch-outs'.
- Optional doors, fans, and casters available.
- Optional anti-tip brackets available.
- Includes (50) 10-32 cage nuts and screws.
- Includes gasket strip material for punch-outs.

### RCSC Doors and Accessories

If security is not important today, but becomes a requirement in the future, locking doors are offered as an accessory. The RCSC Rack Cabinet is designed to use snap-in secure hinges allowing the installation of optional surface-mount doors at any time even when the cabinet is already loaded to capacity.

#### Key features:

- Perforated doors meet server manufacturer Free-Air-Ratio (FAR) requirements at 65%.
- Snap-in hinges can be mounted without having to bolt-on from inside the cabinet.
- Hinges can be mounted on the left or right.
- Doors can be mounted on the front or back.

### RCSC Cabinets

Part#	Units	Overall Height (without casters)	Overall Depth	Maximum Mounting Depth
RCSC1902124BK1	12U	25"	24"	23.5"
RCSC1904224BK1	24U	46"	24"	23.5"
RCSC1902131BK1	12U	25"	31"	29.0"
RCSC1904231BK1	24U	46"	31"	29.0"
RCSC1902136BK1	12U	25"	36"	29.0"
RCSC1904236BK1	24U	46"	36"	29.0"

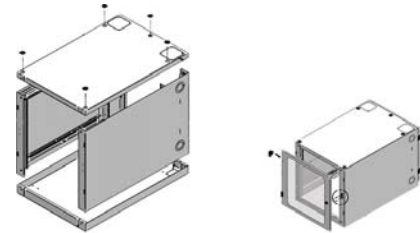

### RCSC Locking Doors

Part#	Description
RCSC19021PDBK1	12U Perforated Door w/lock
RCSC19042PDBK1	24U Perforated Door w/lock

### RCSC Casters

Part#	Description	Rated
1425P	Light-Duty Casters(4)	400lbs
1425BH	Heavy Duty Casters(4)	1000lbs

### RCSC Baying Kit

Part#	Description
RCSCBAY	Baying Kit - bays (2) RCSC's together (vertically or horizontally)

### RCSC Compatible Fan Kit

Part#	Description
RCSCFAN	Fan Kit - includes 2X fans and power cord

### RCSC Anti-Tip Brackets

Part#	Description
RCSCATIP	Anti-tip brackets

Note: The suggested maximum number of units stacked safely is: 3 x 12U cabinets, or 2 x 24U cabinets or one of each size. Maximum weight-load rating per stack of cabinets or per single cabinet is 1500lbs total.

CAUTION: Baying kit (RCSCBAY) is required to lock cabinets together securely when stacking.

## RCHV Series Desktop Cabinets - General-Purpose

www.hammondmg.com



RCHV Series

Includes Combination Rails (2-pairs) and a starter pack of 10-32 clip nuts and screws.



Optional casters and locking doors available! Please visit our web site for more information!



### RCHV Desktop Cabinets

This cost-effective cabinet solution ships flat and assembles in minutes, and is adequate for mounting a variety of devices such as test instruments, audio components and general computing equipment.

#### Key Features:

- User-assembled - assembles in minutes
- EIA compliant combination rails
- Round-hole combination rails w/clip-nuts
- Rails feature infinitely-adjustable depth setting
- Integrated lift handles
- Side ventilation
- Weight-load rated for 800lbs
- Optional casters and solid doors available

\* Note: RCHV series is not intended to house servers.. Please see RCSC series for server applications.

### RCHV Cabinets

Part#	Units	Overall Height (without casters)	Overall Depth	Maximum Mounting Depth
RCHV1900817BK1	5U	10.75"	17.5"	16"
RCHV1901017BK1	6U	12.50"	17.5"	16"
RCHV1901417BK1	8U	16.00"	17.5"	16"
RCHV1901717BK1	10U	19.50"	17.5"	16"
RCHV1902217BK1	13U	24.75"	17.5"	16"
RCHV1902817BK1	16U	30.00"	17.5"	16"
RCHV1901024BK1	6U	12.50"	24.5"	23"
RCHV1901424BK1	8U	16.00"	24.5"	23"
RCHV1901724BK1	10U	19.50"	24.5"	23"
RCHV1902224BK1	13U	24.75"	24.5"	23"
RCHV1902824BK1	16U	30.00"	24.5"	23"
RCHV1901031BK1	6U	12.50"	31.0"	29.5"
RCHV1901431BK1	8U	16.00"	31.0"	29.5"
RCHV1901731BK1	10U	19.50"	31.0"	29.5"
RCHV1902231BK1	13U	24.75"	31.0"	29.5"
RCHV1902831BK1	16U	30.00"	31.0"	29.5"



## DC200 Series - Server Cabinet Assembly

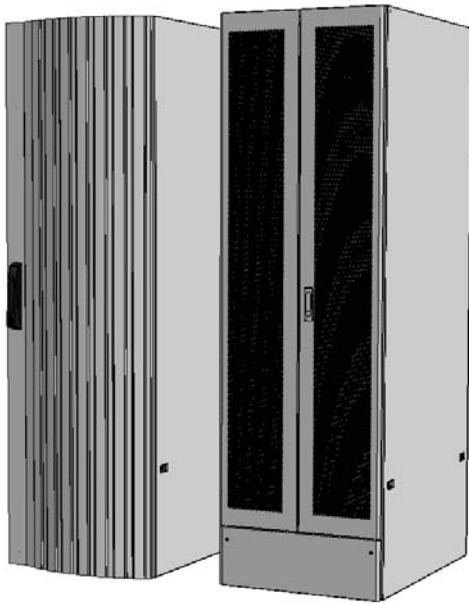

Provides standard 19" rack mounting  
High quality, light textured powder coat finish (black)  
Fits through standard door openings  
Available in sizes shown only

### Assembly includes:

- Sturdy cold-rolled steel frame
- Cable access - top (2 x 4" dia) and bottom (8"x12" opening)
- 2 pair of L-shape, painted mounting rails with "U" space markings - square hole design, includes 40 screws and push-in nuts, and rail depth can adjust in 25mm increments
- Perforated front/rear doors provide excellent ventilation featuring swing handles complete with locks and keys
  - Front door has attractive 4 point latch, curved and ribbed surface for added stability, and can be easily removed and hinged in either direction
  - Rear features split doors making access easier in tight spaces
- Pair of solid side panels are removable and include stiffeners to support the full depth
- 4 casters and 4 leveling feet (casters add approx 2.5" to overall height)

Part Number	Panel Height	Overall Dim's (mm)		
		H	W	D
DC2004242	42U	1997 (78.6")	600 (23.6")	1100 (43.3")
DC2004224	24U	1197 (47.1")	600 (23.6")	1100 (43.3")

Note: For mounting Hammond vertical outlet strips use Part No. **DC2PBCLP**

## Contempra-4 (C4) Series Rack Cabinet System



The C4 Rack Cabinet Series provides users with maximum flexibility:

- Standard C4 assemblies provide easy-ordering for common applications
- Mix and match standard C4 components
- Contact Hammond for special colors, sizes or other modifications

The C4 features a fully-welded 14-gauge steel frame with heavy-duty struts contributing to a weight-load rating of 2000lbs. With an available depth of up to 42", the C4 series can support deep server dimensions while providing ample space for cable management.

**Cable Management** - The 30"-Wide C4 has generous cabling space, four (3.5" wide) cable entry holes on the top, support for up to four optional 4"-deep vertical cable managers, and an open base for easy cable access from raised-tile sub-floors.

**Door Flexibility** - Available options include solid, Plexiglas and perforated versions. Perforated doors are offered in both single and split door designs. Split doors can save valuable working space when accessing the back of the cabinet.

**Thermal Performance** - Perforated doors for both front and back of the cabinet are suggested for most server applications. The C4 cabinet frame features an open-top design supporting optional solid and vented top panels, as well as a selection of fan tops capable of up to 550cfm. Cabinets come standard with an open base design to allow for cable entry and cold-air supply in raised-tile-floor installations. See page 7 for a selection of C4 fan tops, trays and blowers.

**Seismic Ready** - The structural integrity of the standard C4 frame design meets Seismic UBC Zone-4 certification.

**Server-Friendly Universal Square-Hole Panel Rails** - EIA-compliant square-hole design feature U-markings. Infinite-depth setting using C-channel struts. Zinc-plated for superior grounding. The 30"-wide C4 rails have cable-tie support and pass-through holes

**Vertical Cable Managers** - Trays are available for both 24" and 30"-Wide cabinets. The 30"-wide compatible versions feature magnetic-latching doors, and 3.5" wide x 4" deep cable space.

**C4 Base Frame** - 4 leveling feet are included with support for optional recessed casters. Grounding studs provided on frame as well as side panels, top and doors.

### C4 30"-Wide Pre-Assembled (Rapid-Rack) Packages

Includes the following items pre-installed...

- 44U, 30" Wide, 36" or 42" Deep Frame (C4F307742BK1 or C4F307736BK1)
- Zinc-plated Universal Square Hole Mounting Rails (2 pair - C4PR77SZPL) pre-installed
- Solid Side Panels (C4SP7742BK1 or C4SP7736BK1) pre-installed
- Fan top with (1) fan (DNMF100AC115) and fan cord pre-installed
- Vertical Cable Managers (C4VCM77BK1 x 2) pre-installed in cabinet
- Front perf door (standard type - C4DF3077VBK1) pre-installed
- Rear Split perf doors (standard type - C4BD3077VBK1) pre-installed
- 12 Outlet Vertical Power Strip - (1588T12A1BK) pre-installed
- 25 x 10-32 cage nuts (1421CNA25)

Part#	Description	Overall Width	Overall Height	Overall Depth	Shipping Weight
C4RR307736SBK1	C4 Pre-Assembled System	30"	83.5"	36"	390
C4RR307742SBK1	C4 Pre-Assembled System	30"	83.5"	42"	415

Hammond offers other pre-assembled rack cabinet packages not listed in this brochure. Please visit our web site for more information.













Design and Specifications are subject to change without notice.

## Contempra-4 (C4) Series Rack Cabinet System

### Build Your Own C4 Rack Cabinet Assembly

Hammond Manufacturing gives you the choice to either order a C4 cabinet in a convenient pre-assemble package (see page 6) or to order each component separately to build the cabinet solution you need. All C4 cabinet components (and many accessories) are finished in black, textured powder paint. If you require a cabinet with dimensions or colors different from what is shown here, Hammond can easily modify to suit your needs. Please contact your local Hammond sales representative for more information on this service.

Step	Choose Frame Dimension	24" Width Cabinets		30" Wide Cabinet		
		24U 48.5" Overall Ht.	42U 79.3" Overall Ht.	44U 83.5" Overall Ht.		
Step 1 	C4 Frame	31" deep	<input type="checkbox"/> C4F244231BK1	<input type="checkbox"/> C4F247331BK1	<input type="checkbox"/> C4F307731BK1	
		36" deep	<input type="checkbox"/> C4F244236BK1	<input type="checkbox"/> C4F247336BK1	<input type="checkbox"/> C4F307736BK1	
		42" deep	<input type="checkbox"/> C4F244242BK1	<input type="checkbox"/> C4F247342BK1	<input type="checkbox"/> C4F307742BK1	
Step 2 	Solid Side Panels (Pair)	31" deep	<input type="checkbox"/> C4SP4231SBK1	<input type="checkbox"/> C4SP7331SBK1	<input type="checkbox"/> C4SP7731SBK1	
		36" deep	<input type="checkbox"/> C4SP4236SBK1	<input type="checkbox"/> C4SP7336SBK1	<input type="checkbox"/> C4SP7736SBK1	
		42" deep	<input type="checkbox"/> C4SP4242SBK1	<input type="checkbox"/> C4SP7342SBK1	<input type="checkbox"/> C4SP7742SBK1	
	Vented Side Panels (Pair)	31" deep	<input type="checkbox"/> C4SP4231VBK1	<input type="checkbox"/> C4SP7331VBK1	<input type="checkbox"/> C4SP7731VBK1	
		36" deep	<input type="checkbox"/> C4SP4236VBK1	<input type="checkbox"/> C4SP7336VBK1	<input type="checkbox"/> C4SP7736VBK1	
		42" deep	<input type="checkbox"/> C4SP4242VBK1	<input type="checkbox"/> C4SP7342VBK1	<input type="checkbox"/> C4SP7742VBK1	
Step 3 	Add Doors	Solid Door	<input type="checkbox"/> C4DF2442SBK1	<input type="checkbox"/> C4DF2473SBK1	<input type="checkbox"/> C4DF3077SBK1	
		Plexiglass Door	<input type="checkbox"/> C4DF2442PBK1	<input type="checkbox"/> C4DF2473PBK1	<input type="checkbox"/> C4DF3077PBK1	
		Perforated Door 51% F.A.R.	<input type="checkbox"/> C4DF2442VBK1	<input type="checkbox"/> C4DF2473VBK1	<input type="checkbox"/> C4DF3077VBK1	
		Enhanced Perforated Door 65% F.A.R.	<input type="checkbox"/> C4DF2442V65BK1	<input type="checkbox"/> C4DF2473V65BK1	<input type="checkbox"/> C4DF3077V65BK1	
		Perforated Split Doors 51% F.A.R. (Pair)	<input type="checkbox"/> C4BD2442VBK1	<input type="checkbox"/> C4BD2473VBK1	<input type="checkbox"/> C4BD3077VBK1	
Step 4 	Add Mounting Rails (includes 25 Cage Nuts)	Standard Rails (Pair)	<input type="checkbox"/> C4PR2442SZPL	<input type="checkbox"/> C4PR2473SZPL	n/a	
		Extra Wide Rails (Pair)	n/a	n/a	<input type="checkbox"/> C4PR77SZPL	
Step 5 	Add Top Panel	Solid Top Panel	31" deep	<input type="checkbox"/> C2T1923SBK1	<input type="checkbox"/> C2T1923SBK1	<input type="checkbox"/> C2T2423SBK1
			36" deep	<input type="checkbox"/> C2T1931SBK1	<input type="checkbox"/> C2T1931SBK1	<input type="checkbox"/> C2T2431SBK1
			42" deep	<input type="checkbox"/> C2T1936SBK1	<input type="checkbox"/> C2T1936SBK1	<input type="checkbox"/> C2T2436SBK1
		Vented Top Panel	31" deep	<input type="checkbox"/> C2T1923VBK1	<input type="checkbox"/> C2T1923VBK1	<input type="checkbox"/> C2T2423VBK1
			36" deep	<input type="checkbox"/> C2T1931VBK1	<input type="checkbox"/> C2T1931VBK1	<input type="checkbox"/> C2T2431VBK1
			42" deep	<input type="checkbox"/> C2T1936VBK1	<input type="checkbox"/> C2T1936VBK1	<input type="checkbox"/> C2T2436VBK1
		Fan Top Panel (4 or 6 holes) - Pre-wired version also available	31" deep	<input type="checkbox"/> C2T1923FBK1	<input type="checkbox"/> C2T1923FBK1	<input type="checkbox"/> C2T2423FBK1
			36" deep	<input type="checkbox"/> C2T1931FBK1	<input type="checkbox"/> C2T1931FBK1	<input type="checkbox"/> C2T2431FBK1
			42" deep	<input type="checkbox"/> C2T1936FBK1	<input type="checkbox"/> C2T1936FBK1	<input type="checkbox"/> C2T2436FBK1
Step 6 	Add Bottom Panel	Solid Bottom Panel	31" deep	<input type="checkbox"/> C4B2431SBK1	<input type="checkbox"/> C4B2431SBK1	<input type="checkbox"/> C4B3031SBK1
			36" deep	<input type="checkbox"/> C4B2436SBK1	<input type="checkbox"/> C4B2436SBK1	<input type="checkbox"/> C4B3036SBK1
			42" deep	<input type="checkbox"/> C4B2442SBK1	<input type="checkbox"/> C4B2442SBK1	<input type="checkbox"/> C4B3042SBK1
Step 7 	Add Vertical Cable Management	Vertical Open Tray (each)	<input type="checkbox"/> VCT42	<input type="checkbox"/> VCT73	<input type="checkbox"/> VCT78	
		Vertical Cable Manager w/Door (each)	<input type="checkbox"/> C4VCM42BK1	<input type="checkbox"/> C4VCM73BK1	<input type="checkbox"/> C4VCM77BK1	
Step 8 	Add Miscellaneous Hardware	Casters (Set of 4) 1000lb capacity	<input type="checkbox"/> 1425BH	<input type="checkbox"/> 1425BH	<input type="checkbox"/> 1425BH	
		Baying Kit	<input type="checkbox"/> CGH01	<input type="checkbox"/> CGH01	<input type="checkbox"/> CGH01	
		10-32 Black Screws w/washers (25 pack)	<input type="checkbox"/> 1421ABK25	<input type="checkbox"/> 1421ABK25	<input type="checkbox"/> 1421ABK25	
		10-32 Cage Nuts (25 pack)	<input type="checkbox"/> 1421CNA25	<input type="checkbox"/> 1421CNA25	<input type="checkbox"/> 1421CNA25	
		Seismic Bolt-Down Kit	<input type="checkbox"/> C4K-Z4	<input type="checkbox"/> C4K-Z4	<input type="checkbox"/> C4K-Z4	
Step 9	ADD ACCESSORIES		ADD ACCESSORIES		ADD ACCESSORIES	
		SEE PAGE 8		SEE PAGE 9		SEE PAGE 10

## Rack Shelves and Drawers

### Shelves (2-Post Mounting):

Part Number	Description	Units	Depth	Rated
RASU190115BK1	Cantilever Solid Shelf	1U	15"	40lbs
RASU190120BK1	Cantilever Solid Shelf	1U	20"	40lbs
RASU190315BK1	Cantilever Solid Shelf	2U	15"	100lbs
RASU190320BK1	Cantilever Solid Shelf	2U	20"	100lbs
RASU190515BK1	Cantilever Solid Shelf	3U	15"	200lbs
RASU190520BK1	Cantilever Solid Shelf	3U	20"	200lbs
RASU190715BK1	Cantilever Solid Shelf	4U	15"	200lbs
RASU190720BK1	Cantilever Solid Shelf	4U	20"	200lbs
RASV190115BK1	Cantilever Vented Shelf	1U	15"	40lbs
RASV190120BK1	Cantilever Vented Shelf	1U	20"	40lbs
RASV190315BK1	Cantilever Vented Shelf	2U	15"	100lbs
RASV190320BK1	Cantilever Vented Shelf	2U	20"	100lbs
RASV190515BK1	Cantilever Vented Shelf	3U	15"	200lbs
RASV190520BK1	Cantilever Vented Shelf	3U	20"	200lbs
RASV190715BK1	Cantilever Vented Shelf	4U	15"	200lbs
RASV190720BK1	Cantilever Vented Shelf	4U	20"	200lbs

### Storage Drawers (4-Post Mounting Only) *RECOMMENDED*:

Part Number	Description	Units	Surface Depth	Mounting Depth	Rated
RDRW1900322BK1	Locking Drawer	2U	22"	24"	120lbs
RDRW1900522BK1	Locking Drawer	3U	22"	24"	120lbs
RDRW1900722BK1	Locking Drawer	4U	22"	24"	120lbs
RDRW1900822BK1	Locking Drawer	5U	22"	24"	120lbs
RDRW1901222BK1	Locking Drawer	7U	22"	24"	120lbs
RDRW1900316BK1	Locking Drawer	2U	16"	18"	120lbs
RDRW1900516BK1	Locking Drawer	3U	16"	18"	120lbs
RDRW1900716BK1	Locking Drawer	4U	16"	18"	120lbs
RDRW1900816BK1	Locking Drawer	5U	16"	18"	120lbs
RDRW1901216BK1	Locking Drawer	7U	16"	18"	120lbs
RDRW1900312BK1	Locking Drawer	2U	12"	14"	120lbs
RDRW1900512BK1	Locking Drawer	3U	12"	14"	120lbs
RDRW1900712BK1	Locking Drawer	4U	12"	14"	120lbs
RDRW1900812BK1	Locking Drawer	5U	12"	14"	120lbs
RDRW1901212BK1	Locking Drawer	7U	12"	14"	120lbs

### Shelves (4-Post Mounting Only):

Part Number	Description	Units	Surface Depth	Mounting Depth	Rated
RSVS1918BK1	Sliding Shelf - Vented	1U	18"	20"	120lbs
RSVS1921BK1	Sliding Shelf - Vented	1U	21"	22"	120lbs
RSVS1926BK1	Sliding Shelf - Vented	1U	26"	28"	120lbs
RSVS1931BK1	Sliding Shelf - Vented	1U	31"	30"	120lbs
RSUS1918BK1	Sliding Shelf - Solid	1U	18"	20"	120lbs
RSUS1921BK1	Sliding Shelf - Solid	1U	21"	22"	120lbs
RSUS1926BK1	Sliding Shelf - Solid	1U	26"	28"	120lbs
RSUS1931BK1	Sliding Shelf - Solid	1U	31"	30"	120lbs

RSLIDEEX Bracket Upgrade - Increase RSVS/US Mounting-Depth by 14"

RMASU1925BK1	Adj.Depth Shelf - Solid	1U	25"	25" - 35"	75lbs
RMASU1930BK1	Adj.Depth Shelf - Solid	1U	30"	30" - 40"	75lbs

RMASV1925BK1	Adj.Depth Shelf - Vented	1U	25"	25" - 35"	75lbs
RMASV1930BK1	Adj.Depth Shelf - Vented	1U	30"	30" - 40"	75lbs

RMASHD1925BK1	Adj.Depth Shelf - Vented	2U	25"	25" - 35"	200lbs
---------------	--------------------------	----	-----	-----------	--------

### 3 in 1 Shelf (2 or 4 Post Mounting):

Part Number	Description	Units	Surface Depth	Mounting Depth	Rated
RMS193BK1	Keyboard Shelf Drawer	3U	18.75"	18.3"	not rated

### Keyboard Drawers (4-Post Mounting Only):

Part Number	Description	Units	Surface Depth	Mounting Depth	Rated
RAKS19BK1	Narrow Keyboard Drawer	1U	15"	18"	120lbs
RSLIDEEX	Bracket Upgrade - Increase RSVS/US Mounting-Depth by 14"				
RSKS19005BK1	Full-Size Keyboard Drawer	3U	20"	34"	120lbs

## Cable Managers and Power Distribution Products

### Cable Management Products:

Part Number	Description	Units	Overall Height	Overall Depth
PCMDD19001BK1	Hinged Horizontal Cable Manager	1U	1.75"	2.5"
PCMDD19003BK1	Hinged Horizontal Cable Manager	2U	3.5"	2.5"
PCMDD19005BK1	Hinged Horizontal Cable Manager	3U	5.25"	2.5"
PCMDS19001BK1	Hinged Finger Panel	1U	1.75"	3"
PCMDS19003BK1	Hinged Finger Panel	2U	3.5"	3"
PCMDS19005BK1	Hinged Finger Panel	3U	5.25"	3"

PCMBV19001BK1	Velcro Strap Panel	1U	1.75"	-
---------------	--------------------	----	-------	---

CMRBK1	Single Cable Ring - 1.25" Wide	1U	1.75"	3.5"
CMR3BK1	Single Cable Ring - 1.25" Wide	2U	3.5"	3.5"

PCMT19003BK1	Rack Panel Mount Trough	2U	3.5"	-
--------------	-------------------------	----	------	---

CGUIDE	Hinged Cable Guide w/tie straps	2U	3.5"	-
--------	---------------------------------	----	------	---

CMSTRAPS	5 Velcro Straps - Supports Max. 3.5" diameter bundles			
----------	---	--	--	--

### Power Distribution Products:

Part Number	Description	Cord Length	# of Outlets	Overall Height	Amp Rating
1588T12A1BK	Vertical Strip (Black)	6'	12	77"	15Amp
15854T7A1	Vertical Strip (Silver)	6'	7	42"	15Amp

1582T6A1BK	Horizontal Strip	6'	6	1.72"	15Amp
1582T8A1BK	Horizontal Strip	6'	8	1.72"	15Amp
1589H6F1BKRR	Horizontal Strip	6'	6	1.72"	20Amp

1583T6A1BKAM	Horizontal Strip w/Ammeter	6'	6	1.72"	15Amp
1589T6F1BKRRAM	Horizontal Strip w/Ammeter	6'	6	1.72"	20Amp

The above Power Distribution Products consist of only a few product models. Please see page 10 for the full list of models and specifications.



### Vertical Cable Managers with Door

C4VCM77BK1 C4 (44U) Vertical Cable Manager

- Magnetic Latching Door
- Integrated Cable Ties
- 3.5" Wide x 4" Deep
- Exclusively compatible with the C4
- 30"-Wide 44U Cabinet

See Page 6 and 7 for more information.



### Vertical Cable Trays

- Available to support all matching C4 heights
- Integrated Cable Ties

See Page 6 and 7 for available sizes and part numbers

## Rack Fan Trays

- 1U 19" Rack Mount Fan Trays
- Ideal solution for hot spots
- Integral finger guards
- Circuit breaker protection
- Black powder paint finish



Part Number	Description	Max Mounting Depth
FT300TA1BK	3-Fan,300CFM, Pilot Light	Unlimited
FT600TA1BK	6-Fan,600CFM, Pilot Light	19.2"
FT900TA1BK	9-Fan,900CFM, Pilot Light	24.7"
FT300HA1BK	3-Fan,300CFM, ON/OFF Switch	Unlimited
FT600HA1BK	6-Fan,600CFM, ON/OFF Switch	19.2"
FT900HA1BK	9-Fan,900CFM, ON/OFF Switch	24.7"

## Fan Panel Assembly

- 3U 19" Rack Mount Fan Panel
- Can mount on rear rack rails
- Target hot-spots
- Integral finger guards
- 210 CFM total
- Includes 24" power cable



Part#	Description
PPGPFPA	Fan Grill Panel, 3U spaces, 2 x 4.7" fans, power cable

## C4 Pre-Wired Fan Tops

Fan Top w/4 x 4.7" fans (420 CFM)	24"-Wide C4	30"-Wide C4
	24" Deep C4 C2T1923F4BK1	C2T2423F4BK1
	31" Deep C4 C2T1923F4BK1	C2T2423F4BK1
	36" Deep C4 C2T1931F4BK1	C2T2431F4BK1
	42" Deep C4 C2T1936F4BK1	C2T2436F4BK1

Fan Top w/1 x 10" fan (550 CFM)	24"-Wide C4	30"-Wide C4
	24" Deep C4 C2T1923F10BK1	C2T2423F10BK1
	31" Deep C4 C2T1923F10BK1	C2T2423F10BK1
	36" Deep C4 C2T1931F10BK1	C2T2431F10BK1
	42" Deep C4 C2T1936F10BK1	C2T2436F10BK1

## Fan Top Components

- For use with cabinet fan tops



Part#	Description
DNMF100AC115	4.7" Fan - 105CFM
DNFG	Fan Guard
DNFCDC2P	Daisy Chain 2-Fan Cord - Lead Length 24"
DNFC48P	Single Fan Cord - Lead Length 48"

## Raised-Floor Blower

- Produces a curtain of cooled air in front of a server rack.
- Pulls cold air from below a raised floor.
- 2U space required
- Filter is optional
- Includes mounting hardware



Part#	Description
DCDELB	Delphi Blower

## Thermostat

- Controls fan trays panels & tops
- Adjustable range 30-140 degrees F
- Normally-Open Switch
- Switching capacity of 15A (120VAC)
- Available in Fahrenheit or Celsius



Part#	Description
SKT011419NO	Thermostat (Fahrenheit Scale)
SKT011419NO-C	Thermostat (Celsius Scale)



## Standard Steel Blanking Panels

Blanking panels can be installed in unused rack unit spaces within a cabinet to improve both cooling efficiency and system esthetics.

Part Number	Description
PBPS19001BK2	Steel Blanking Panel (1U)
PBPS19003BK2	Steel Blanking Panel (2U)
PBPS19005BK2	Steel Blanking Panel (3U)



## Formed Steel Blanking Panels

Angled edging for greater rigidity

Part Number	Description
PBFS19001BK2	Formed Steel Blanking Panel (1U)
PBFS19003BK2	Formed Steel Blanking Panel (2U)
PBFS19005BK2	Formed Steel Blanking Panel (3U)



## Perforated Steel Blanking Panels

Can be used in natural-convection applications, where a device must be secure while providing ventilation.

Part Number	Description
PPFS19001BK2	Steel Perf Blanking Panel (1U)
PPFS19003BK2	Steel Perf Blanking Panel (2U)
PPFS19005BK2	Steel Perf Blanking Panel (3U)



## Steel Baffle Panel

Rear sloping baffle can help direct air out of a cabinet in a natural-convection application.

Part#	Description
PVBB19001BK2	Baffle Panel (1U)

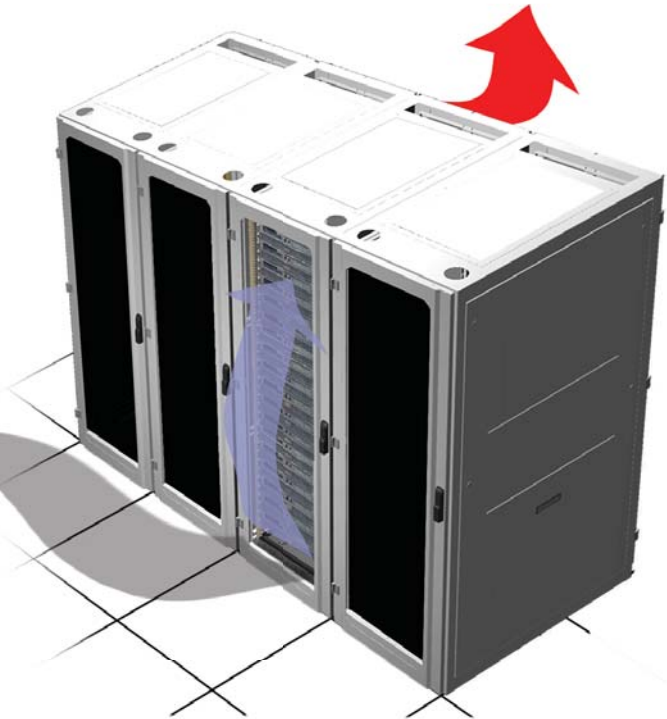

## NEMA-12 Cabinets with Cooling Solutions

Hammond specializes in cabinet solutions designed for factory environments under NEMA-12 specification, and where cabinet air-conditioning systems may also be required.

If your project demands superior protection against oil, dirt, dust, lint, and liquids, contact your Hammond sales representative today!



Please visit ...  
[www.hammondmg.com](http://www.hammondmg.com)  
for more information!

## Horizontal Rack Mount Outlet Strips

All Hammond Power Strips on this page include a 125 VAC circuit breaker, use 1U (1.75") panel space, and are finished in black.

Further pictures, drawings and specifications are available on our web site....

[www.hammondmfg.com](http://www.hammondmfg.com)



### 15 Amp Outlet Strips with FRONT-Mounted Receptacles

CSA certified, Standards C22.2 (No. 21-95, No. 42-99 and No. 8-M1986)  
UL recognized, Standards UL1363, UL1449 and UL1283 - file # E166039

Part Number	# of Outlets on Front	Power Indication		Surge Protection	Cord Length	Plug Type	Amp Rating	Color
		Lighted On/Off Switch	Pilot Light Only					
1582H6A1BK	6	Yes	-	No	6'	Straight	15 Amp	Black
1582H6B1BK	6	Yes	-	No	15'	Straight	15 Amp	Black
1582H6C1BK	6	Yes	-	No	6'	Twist-Lock	15 Amp	Black
1582H6D1BK	6	Yes	-	No	15'	Twist-Lock	15 Amp	Black
1582H8A1BK	8	Yes	-	No	6'	Straight	15 Amp	Black
1582H8B1BK	8	Yes	-	No	15'	Straight	15 Amp	Black
1582H8C1BK	8	Yes	-	No	6'	Twist-Lock	15 Amp	Black
1582H8D1BK	8	Yes	-	No	15'	Twist-Lock	15 Amp	Black
1582T6A1BK	6	-	Yes	No	6'	Straight	15 Amp	Black
1582T6B1BK	6	-	Yes	No	15'	Straight	15 Amp	Black
1582T6C1BK	6	-	Yes	No	6'	Twist-Lock	15 Amp	Black
1582T6D1BK	6	-	Yes	No	15'	Twist-Lock	15 Amp	Black
1582T8A1BK	8	-	Yes	No	6'	Straight	15 Amp	Black
1582T8B1BK	8	-	Yes	No	15'	Straight	15 Amp	Black
1582T8C1BK	8	-	Yes	No	6'	Twist-Lock	15 Amp	Black
1582T8D1BK	8	-	Yes	No	15'	Twist-Lock	15 Amp	Black
1582H6A1SBK	6	Yes	-	YES	6'	Straight	15 Amp	Black
1582H6B1SBK	6	Yes	-	YES	15'	Straight	15 Amp	Black
1582H6C1SBK	6	Yes	-	YES	6'	Twist-Lock	15 Amp	Black
1582H6D1SBK	6	Yes	-	YES	15'	Twist-Lock	15 Amp	Black



### 15 Amp Outlet Strips with FRONT AND REAR-Mounted Receptacles

CSA certified, Standards C22.2 (No. 21-95, No. 42-99 and No. 8-M1986)  
UL recognized, Standards UL1363, UL1449 and UL1283 - file # E166039

Part Number	# of Outlets Front + Rear	Power Indication		Surge Protection	Cord Length	Plug Type	Amp Rating	Color
		Lighted On/Off Switch	Pilot Light Only					
1583H6A1BKX	2 + 4	Yes	-	No	6'	Straight	15 Amp	Black
1583H6B1BKX	2 + 4	Yes	-	No	15'	Straight	15 Amp	Black
1583H6C1BKX	2 + 4	Yes	-	No	6'	Twist-Lock	15 Amp	Black
1583H6D1BKX	2 + 4	Yes	-	No	15'	Twist-Lock	15 Amp	Black
1583T6A1BKX	2 + 4	-	Yes	No	6'	Straight	15 Amp	Black
1583T6B1BKX	2 + 4	-	Yes	No	15'	Straight	15 Amp	Black
1583T6C1BKX	2 + 4	-	Yes	No	6'	Twist-Lock	15 Amp	Black
1583T6D1BKX	2 + 4	-	Yes	No	15'	Twist-Lock	15 Amp	Black
1583H12A1BKX	6 + 6	Yes	-	No	6'	Straight	15 Amp	Black
1583H12B1BKX	6 + 6	Yes	-	No	15'	Straight	15 Amp	Black
1583H12C1BKX	6 + 6	Yes	-	No	6'	Twist-Lock	15 Amp	Black
1583H12D1BKX	6 + 6	Yes	-	No	15'	Twist-Lock	15 Amp	Black
1583T12A1BKX	6 + 6	-	Yes	Yes	6'	Straight	15 Amp	Black
1583T12B1BKX	6 + 6	-	Yes	Yes	15'	Straight	15 Amp	Black
1583T12C1BKX	6 + 6	-	Yes	Yes	6'	Twist-Lock	15 Amp	Black
1583T12D1BKX	6 + 6	-	Yes	Yes	15'	Twist-Lock	15 Amp	Black

### 20-Amp Outlet Strips with FRONT OR REAR-Mounted Receptacles

Part Number	# of Outlets Front + Rear	Power Indication		Surge Protection	Cord Length	Plug Type	Amp Rating	Color
		Lighted On/Off Switch	Pilot Light Only					
1589H6C1BKRF	6 + 0	Yes	-	No	6'	Straight	20 Amp	Black
1589H6D1BKRF	6 + 0	Yes	-	No	15'	Straight	20 Amp	Black
1589H6F1BKRF	6 + 0	Yes	-	No	6'	Twist-Lock	20 Amp	Black
1589H6G1BKRF	6 + 0	Yes	-	No	15'	Twist-Lock	20 Amp	Black
1589T6C1BKRF	6 + 0	-	Yes	No	6'	Straight	20 Amp	Black
1589T6D1BKRF	6 + 0	-	Yes	No	15'	Straight	20 Amp	Black
1589T6F1BKRF	6 + 0	-	Yes	No	6'	Twist-Lock	20 Amp	Black
1589T6G1BKRF	6 + 0	-	Yes	No	15'	Twist-Lock	20 Amp	Black
1589H6C1BKRR	0 + 6	Yes	-	No	6'	Straight	20 Amp	Black
1589H6D1BKRR	0 + 6	Yes	-	No	15'	Straight	20 Amp	Black
1589H6F1BKRR	0 + 6	Yes	-	No	6'	Twist-Lock	20 Amp	Black
1589H6G1BKRR	0 + 6	Yes	-	No	15'	Twist-Lock	20 Amp	Black
1589T6C1BKRR	0 + 6	-	Yes	No	6'	Straight	20 Amp	Black
1589T6D1BKRR	0 + 6	-	Yes	No	15'	Straight	20 Amp	Black
1589T6F1BKRR	0 + 6	-	Yes	No	6'	Twist-Lock	20 Amp	Black
1589T6G1BKRR	0 + 6	-	Yes	No	15'	Twist-Lock	20 Amp	Black

## Plug Types



### 15 Amp Outlet Strips with REAR-Mounted Receptacles

CSA certified, Standards C22.2 (No. 21-95, No. 42-99 and No. 8-M1986)  
UL recognized, Standards UL1363, UL1449 and UL1283 - file # E166039

Part Number	# of Outlets on Rear	Power Indication		Surge Protection	Cord Length	Plug Type	Amp Rating	Color
		Lighted On/Off Switch	Pilot Light Only					
1583H6A1BK	6	Yes	-	No	6'	Straight	15 Amp	Black
1583H6B1BK	6	Yes	-	No	15'	Straight	15 Amp	Black
1583H6C1BK	6	Yes	-	No	6'	Twist-Lock	15 Amp	Black
1583H6D1BK	6	Yes	-	No	15'	Twist-Lock	15 Amp	Black
1583H8A1BK	8	Yes	-	No	6'	Straight	15 Amp	Black
1583H8B1BK	8	Yes	-	No	15'	Straight	15 Amp	Black
1583H8C1BK	8	Yes	-	No	6'	Twist-Lock	15 Amp	Black
1583H8D1BK	8	Yes	-	No	15'	Twist-Lock	15 Amp	Black
1583T6A1BK	6	-	Yes	No	6'	Straight	15 Amp	Black
1583T6B1BK	6	-	Yes	No	15'	Straight	15 Amp	Black
1583T6C1BK	6	-	Yes	No	6'	Twist-Lock	15 Amp	Black
1583T6D1BK	6	-	Yes	No	15'	Twist-Lock	15 Amp	Black
1583T8A1BK	8	-	Yes	No	6'	Straight	15 Amp	Black
1583T8B1BK	8	-	Yes	No	15'	Straight	15 Amp	Black
1583T8C1BK	8	-	Yes	No	6'	Twist-Lock	15 Amp	Black
1583T8D1BK	8	-	Yes	No	15'	Twist-Lock	15 Amp	Black
1583H6A1SBK	6	Yes	-	Yes	6'	Straight	15 Amp	Black
1583H6B1SBK	6	Yes	-	Yes	15'	Straight	15 Amp	Black
1583H6C1SBK	6	Yes	-	Yes	6'	Twist-Lock	15 Amp	Black
1583H6D1SBK	6	Yes	-	Yes	15'	Twist-Lock	15 Amp	Black



### 15 Amp Outlet Strips with 90 Degree Offset Receptacles

CSA certified, Standards C22.2 (No. 21-95, No. 42-99 and No. 8-M1986)  
UL recognized, Standards UL1363, UL1449 and UL1283 - file # E166039

Part Number	# of Outlets Front + Rear	Power Indication		Surge Protection	Cord Length	Plug Type	Amp Rating	Color
		Lighted On/Off Switch	Pilot Light Only					
1582H6A1BKRA	6 + 0	Yes	-	No	6'	Straight	15 Amp	Black
1582H6B1BKRA	6 + 0	Yes	-	No	15'	Straight	15 Amp	Black
1582H6C1BKRA	6 + 0	Yes	-	No	6'	Twist-Lock	15 Amp	Black
1582H6D1BKRA	6 + 0	Yes	-	No	15'	Twist-Lock	15 Amp	Black
1582T6A1BKRA	6 + 0	-	Yes	No	6'	Straight	15 Amp	Black
1582T6B1BKRA	6 + 0	-	Yes	No	15'	Straight	15 Amp	Black
1582T6C1BKRA	6 + 0	-	Yes	No	6'	Twist-Lock	15 Amp	Black
1582T6D1BKRA	6 + 0	-	Yes	No	15'	Twist-Lock	15 Amp	Black
1583H6A1BKRA	0 + 6	Yes	-	No	6'	Straight	15 Amp	Black
1583H6B1BKRA	0 + 6	Yes	-	No	15'	Straight	15 Amp	Black
1583H6C1BKRA	0 + 6	Yes	-	No	6'	Twist-Lock	15 Amp	Black
1583H6D1BKRA	0 + 6	Yes	-	No	15'	Twist-Lock	15 Amp	Black
1583T6A1BKRA	0 + 6	-	Yes	No	6'	Straight	15 Amp	Black
1583T6B1BKRA	0 + 6	-	Yes	No	15'	Straight	15 Amp	Black
1583T6C1BKRA	0 + 6	-	Yes	No	6'	Twist-Lock	15 Amp	Black
1583T6D1BKRA	0 + 6	-	Yes	No	15'	Twist-Lock	15 Amp	Black

### 15 Amp and 20-Amp Outlet Strips with built-in AMMETER



- Unit includes easy to read 0.37" high red LED ammeter (1.38" x 0.88" display).
- Ammeter accuracy +/- 0.1 Amps

The 1583 series (15 Amp. version) are cULus recognized to Standard UL1363 - file # E166039.  
The 1589 series (20 Amp. version) are cULus listed to Standard UL1363 - file # E166039.

Part Number	# of Outlets on Rear	On/Off Switch	Pilot Light Only	Surge Protection	Cord Length	Plug Type	Amp Rating	Color
1583H6B1BKAM	6	Lighted	-	No	15'	Straight	15 Amp	Black
1583T6A1BKAM	6	-	YES	No	6'	Straight	15 Amp	Black
1583T6B1BKAM	6	-	YES	No	15'	Straight	15 Amp	Black
1589H6C1BKRRAM	6	No Light	-	No	6'	Twist-Lock	20 Amp	Black
1589H6F1BKRRAM	6	No Light	-	No	15'	Straight	20 Amp	Black
1589T6C1BKRRAM	6	-	Yes	No	6'	Twist-Lock	20 Amp	Black
1589T6F1BKRRAM	6	-	Yes	No	15'	Straight	20 Amp	Black

## Vertical Rack Mount Outlet Strips

### 15 Amp Vertical Outlet Strips

Part Number Version w/ Pilot Light	Part Number Version w/Lighted On/Off Switch	# of Outlets	Strip Length	Surge Protection	Cord Length	Plug Type	Amp Rating	Color
15851T6A1	15851H6A1	6	18"	No	6'	Straight	15 Amp	Silver
15851T6B1	15851H6B1	6	18"	No	15'	Straight	15 Amp	Silver
15851T6C1	15851H6C1	6	18"	No	6'	Twist-Lock	15 Amp	Silver
15851T6D1	15851H6D1	6	18"	No	15'	Twist-Lock	15 Amp	Silver
15852T6A1	15852H6A1	6	24"	No	6'	Straight	15 Amp	Silver
15852T6B1	15852H6B1	6	24"	No	15'	Straight	15 Amp	Silver
15852T6C1	15852H6C1	6	24"	No	6'	Twist-Lock	15 Amp	Silver
15852T6D1	15852H6D1	6	24"	No	15'	Twist-Lock	15 Amp	Silver
15852T8A1	15852H8A1	8	24"	No	6'	Straight	15 Amp	Silver
15852T8B1	15852H8B1	8	24"	No	15'	Straight	15 Amp	Silver
15852T8C1	15852H8C1	8	24"	No	6'	Twist-Lock	15 Amp	Silver
15852T8D1	15852H8D1	8	24"	No	15'	Twist-Lock	15 Amp	Silver
15853T6A1	15853H6A1	6	36"	No	6'	Straight	15 Amp	Silver
15853T6B1	15853H6B1	6	36"	No	15'	Straight	15 Amp	Silver
15853T6C1	15853H6C1	6	36"	No	6'	Twist-Lock	15 Amp	Silver
15853T6D1	15853H6D1	6	36"	No	15'	Twist-Lock	15 Amp	Silver
15854T7A1	15854H7A1	7	42"	No	6'	Straight	15 Amp	Silver
15854T7B1	15854H7B1	7	42"	No	15'	Straight	15 Amp	Silver
15854T7C1	15854H7C1	7	42"	No	6'	Twist-Lock	15 Amp	Silver
15854T7D1	15854H7D1	7	42"	No	15'	Twist-Lock	15 Amp	Silver
1585T8A1	1585H8A1	8	48"	No	6'	Straight	15 Amp	Silver
1585T8A1BK	1585H8A1BK	8	48"	No	6'	Straight	15 Amp	Black
1585T8B1	1585H8B1	8	48"	No	15'	Straight	15 Amp	Silver
1585T8B1BK	1585H8B1BK	8	48"	No	15'	Straight	15 Amp	Black
1585T8C1	1585H8C1	8	48"	No	6'	Twist-Lock	15 Amp	Silver
1585T8D1	1585H8D1	8	48"	No	15'	Twist-Lock	15 Amp	Silver
1585T10A1	1585H10A1	10	48"	No	6'	Straight	15 Amp	Silver
1585T10B1	1585H10B1	10	48"	No	15'	Straight	15 Amp	Silver
1585T10C1	1585H10C1	10	48"	No	6'	Twist-Lock	15 Amp	Silver
1585T10D1	1585H10D1	10	48"	No	15'	Twist-Lock	15 Amp	Silver
1585T11A1	1585H11A1	11	48"	No	6'	Straight	15 Amp	Silver
1585T11B1	1585H11B1	11	48"	No	15'	Straight	15 Amp	Silver
1585T11C1	1585H11C1	11	48"	No	6'	Twist-Lock	15 Amp	Silver
1585T11D1	1585H11D1	11	48"	No	15'	Twist-Lock	15 Amp	Silver
1585T15A1	1585H15A1	15	48"	No	6'	Straight	15 Amp	Silver
1585T15B1	1585H15B1	15	48"	No	15'	Straight	15 Amp	Silver
1585T15C1	1585H15C1	15	48"	No	6'	Twist-Lock	15 Amp	Silver
1585T15D1	1585H15D1	15	48"	No	15'	Twist-Lock	15 Amp	Silver
1585T16A1	1585H16A1	16	48"	No	6'	Straight	15 Amp	Silver
1585T16B1	1585H16B1	16	48"	No	15'	Straight	15 Amp	Silver
1585T16C1	1585H16C1	16	48"	No	6'	Twist-Lock	15 Amp	Silver
1585T16D1	1585H16D1	16	48"	No	15'	Twist-Lock	15 Amp	Silver
1586T10A1	1586H10A1	10	60"	No	6'	Straight	15 Amp	Silver
1586T10B1	1586H10B1	10	60"	No	15'	Straight	15 Amp	Silver
1586T10C1	1586H10C1	10	60"	No	6'	Twist-Lock	15 Amp	Silver
1586T10D1	1586H10D1	10	60"	No	15'	Twist-Lock	15 Amp	Silver
1586T12A1	1586H12A1	12	60"	No	6'	Straight	15 Amp	Silver
1586T12A1BK	1586H12A1BK	12	60"	No	6'	Straight	15 Amp	Black
1586T12B1	1586H12B1	12	60"	No	15'	Twist-Lock	15 Amp	Silver
1586T12B1BK	1586H12B1BK	12	60"	No	15'	Twist-Lock	15 Amp	Black
1586T12C1	1586H12C1	12	60"	No	6'	Twist-Lock	15 Amp	Silver
1586T12D1	1586H12D1	12	60"	No	15'	Twist-Lock	15 Amp	Silver
1587T10A1	1587H10A1	10	70"	No	6'	Straight	15 Amp	Silver
1587T10A1BK	1587H10A1BK	10	70"	No	6'	Straight	15 Amp	Black
1587T10B1	1587H10B1	10	70"	No	15'	Straight	15 Amp	Silver
1587T10B1BK	1587H10B1BK	10	70"	No	15'	Straight	15 Amp	Black
1587T10C1	1587H10C1	10	70"	No	6'	Twist-Lock	15 Amp	Silver
1587T10D1	1587H10D1	10	70"	No	15'	Twist-Lock	15 Amp	Silver
1587T11A1	1587H11A1	11	70"	No	6'	Straight	15 Amp	Silver
1587T11B1	1587H11B1	11	70"	No	15'	Straight	15 Amp	Silver
1587T11C1	1587H11C1	11	70"	No	6'	Twist-Lock	15 Amp	Silver
1587T11D1	1587H11D1	11	70"	No	15'	Twist-Lock	15 Amp	Silver
1587T12A1	1587H12A1	12	70"	No	6'	Straight	15 Amp	Silver
1587T12B1	1587H12B1	12	70"	No	15'	Straight	15 Amp	Silver
1587T12C1	1587H12C1	12	70"	No	6'	Twist-Lock	15 Amp	Silver
1587T12D1	1587H12D1	12	70"	No	15'	Twist-Lock	15 Amp	Silver
1587T19A1	1587H19A1	19	70"	No	6'	Straight	15 Amp	Silver
1587T19B1	1587H19B1	19	70"	No	15'	Straight	15 Amp	Silver
1587T19C1	1587H19C1	19	70"	No	6'	Twist-Lock	15 Amp	Silver
1587T19D1	1587H19D1	19	70"	No	15'	Twist-Lock	15 Amp	Silver
1587T24A1	1587H24A1	24	70"	No	6'	Straight	15 Amp	Silver
1587T24B1	1587H24B1	24	70"	No	15'	Straight	15 Amp	Silver
1587T24C1	1587H24C1	24	70"	No	6'	Twist-Lock	15 Amp	Silver
1587T24D1	1587H24D1	24	70"	No	15'	Twist-Lock	15 Amp	Silver
1588T12A1	1588H12A1	12	77"	No	6'	Straight	15 Amp	Silver
1588T12A1BK	1588H12A1BK	12	77"	No	6'	Straight	15 Amp	Black
1588T12B1	1588H12B1	12	77"	No	15'	Straight	15 Amp	Silver
1588T12B1BK	1588H12B1BK	12	77"	No	15'	Straight	15 Amp	Black
1588T12C1	1588H12C1	12	77"	No	6'	Twist-Lock	15 Amp	Silver
1588T12D1	1588H12D1	12	77"	No	15'	Twist-Lock	15 Amp	Silver

#### Features:

- Receptacles are 1" square and are equally spaced over the length of the power strip.
- Built-in 15 Amp, 120 VAC circuit breaker.
- Black or Silver (Natural)
- Finish as specified



CSA certified, Standards C22.2 (No. 21-95 and No. 42-99)  
UL listed, Standard UL1363 - file # E166039

Each Vertical Outlet Strip includes a mounting clip kit containing necessary hardware required to mount a vertical outlet strip to a rack cabinet, amhal struts or open relay racks.



Additional kits can be purchased by ordering part# **1585CLIP**

When mounting to DC200 series use Part No. **DC2PBCLP**

### 15 Amp Vertical Outlet Strips with Surge Protection

Part Number Version w/ Pilot Light	Part Number Version w/Lighted On/Off Switch	# of Outlets	Strip Length	Surge Protection	Cord Length	Plug Type	Amp Rating	Color
1585T8A1S	1585H8A1S	8	48"	Yes	6'	Straight	15 Amp	Silver
1585T8B1S	1585H8B1S	8	48"	Yes	15'	Straight	15 Amp	Silver
1585T10A1S	1585H10A1S	10	48"	Yes	6'	Straight	15 Amp	Silver
1585T10B1S	1585H10B1S	10	48"	Yes	15'	Straight	15 Amp	Silver
1585T15A1S	1585H15A1S	15	48"	Yes	6'	Straight	15 Amp	Silver
1585T15B1S	1585H15B1S	15	48"	Yes	15'	Straight	15 Amp	Silver
1587T11A1S	1587H11A1S	11	70"	Yes	6'	Straight	15 Amp	Silver
1587T11B1S	1587H11B1S	11	70"	Yes	15'	Straight	15 Amp	Silver
1587T19A1S	1587H19A1S	19	70"	Yes	6'	Straight	15 Amp	Silver
1587T19B1S	1587H19B1S	19	70"	Yes	15'	Straight	15 Amp	Silver
1588T12A1S	1588H12A1S	12	77"	Yes	6'	Straight	15 Amp	Silver
1588T12B1S	1588H12B1S	12	77"	Yes	15'	Straight	15 Amp	Silver

20-Amp Vertical Outlet Strips also available!

Additional pictures, drawings, models and specifications are available on our web site...

[www.hammondmfg.com](http://www.hammondmfg.com)

#### Plug Types



"Straight Blade"  
NEMA 5-15P

"Twist-Lock"  
NEMA L5-15P

"Straight Blade"  
NEMA 5-20P

"Twist-Lock"  
NEMA L5-20P

www.hammondmfg.com

## Hammond Manufacturing

# Electronic and Electrical Product Catalogs

Catalog  
9R-05



Electronic  
Racks

Catalog  
PB-02

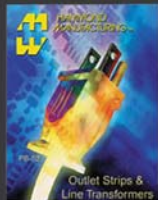

Power Outlet  
Strips

Catalog  
5C-08

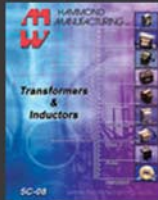

Transformers  
& Inductors

Catalog  
E-5



Industrial  
Electrical  
Enclosures

Catalog  
9C-05



Electronic  
Enclosures

Contact one of our offices below to order a catalog today!

### CANADA

Hammond Manufacturing Company Limited  
394 Edinburgh Road, North  
Guelph, Ontario N1H 1E5  
CANADA

Phone (519) 822-2960  
Alt Tel (905) 456-3770  
Fax (519) 822-0715  
ca-info@hammondmfg.com

Les Fabrications Hammond (Quebec) Inc.  
4240, Seré  
St. Laurent, Quebec H4T 1A6  
CANADA

Phone (514) 343-9010  
Fax (514) 343-9941  
quebec@hammondmfg.com

### USA

Hammond Manufacturing Company Inc.  
475 Cayuga Rd. #100  
Cheektowaga, NY  
14225-1309 USA

Phone (716) 630-7030  
Fax (716) 630-7042  
us-info@hammondmfg.com

### EUROPE

Hammond Electronics Limited  
1 Onslow Close  
Kingsland Business Park, Basingstoke  
Hampshire RG24 8QL  
UNITED KINGDOM

Phone 01256 812812  
Fax 01256 332249  
uk-info@hammondmfg.com

### AUSTRALIA

Hammond Electronics Pty Ltd  
ABN 13 099 121 981  
11 - 13 Port Rd.  
Queenstown SA 5014  
AUSTRALIA

Phone +61-8-8240-2244  
Fax: +61-8-8240-2255  
oz-info@hammondmfg.com



Distributed by:

Design and Specifications are  
subject to change without notice

ISO 9001:2000  
CERTIFIED



Printed in Canada  
© Hammond Manufacturing Company Limited